











440 HORIZONT A-CNC

34×1,1

					
440	430	290	430	290	x
610x385	430x385	290x385	430x385	290x385	610x350
					
3×400V 50 Hz	4,0	15-150	6060×34×1,1	3280	
Lmax 4387	B 6013	Hmin 2168	Hmax 2225	V 810	



STANDARD OPTION

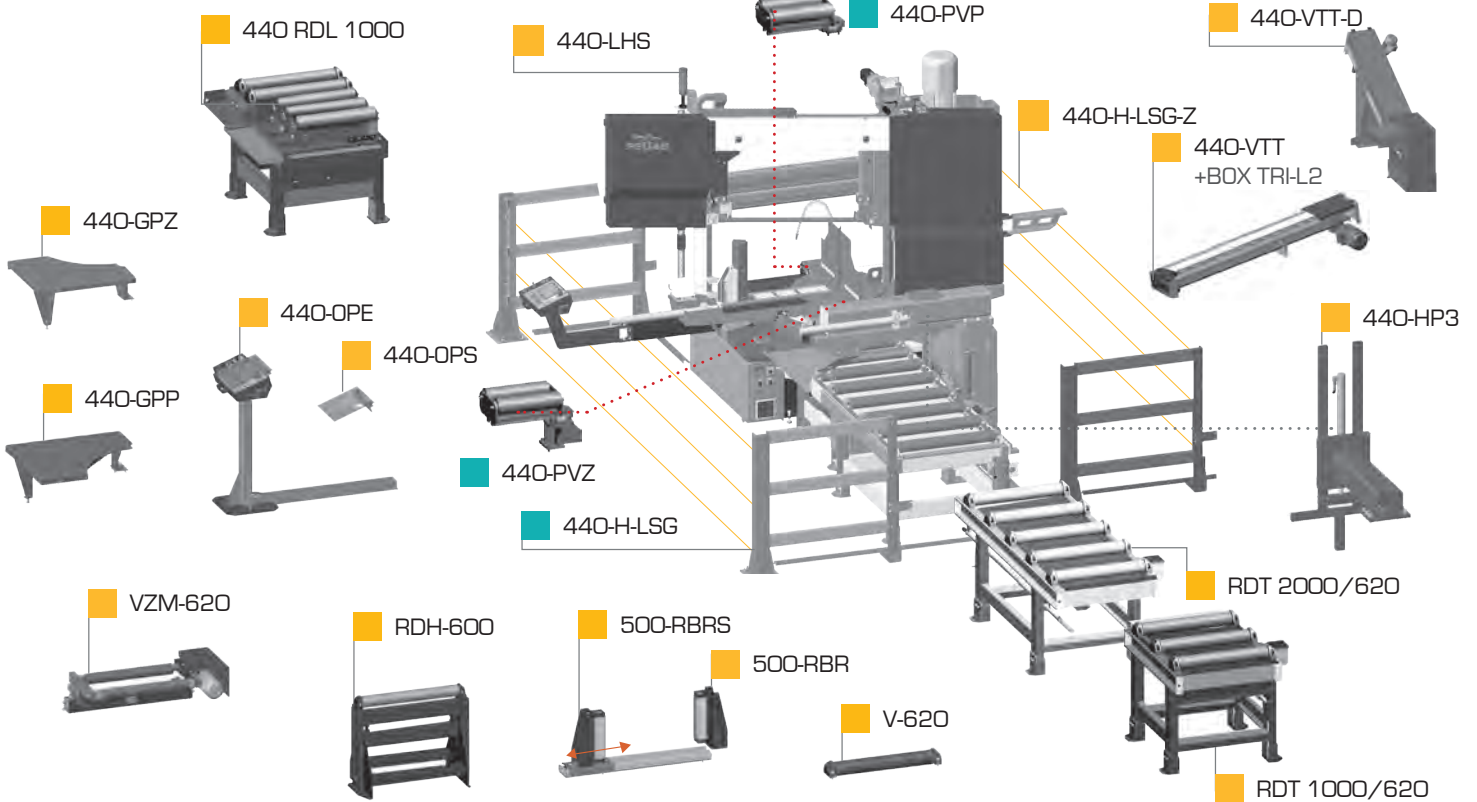
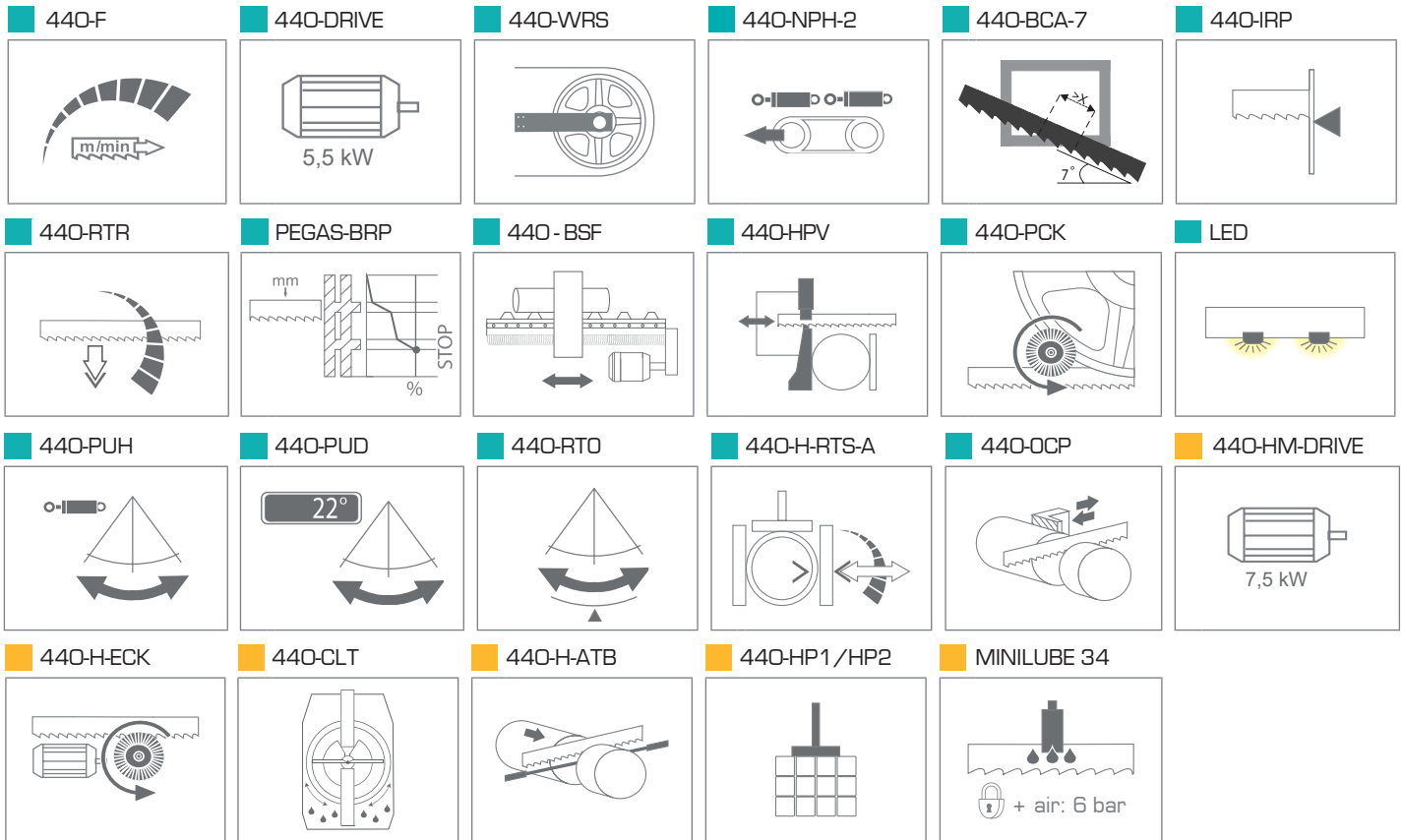

440 HORIZONT A-CNC

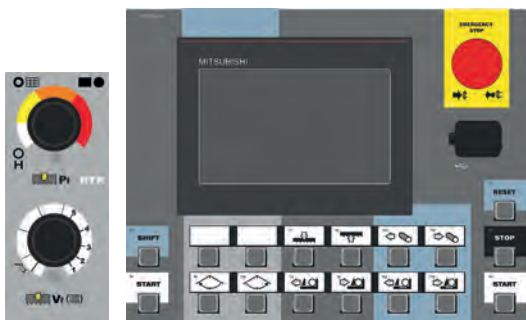

RTR

CONTROL PANEL: MITSUBISHI (A-CNC)

- výrobce si vyhrazuje právo provádět změny technických údajů, technické údaje odpovídají 1.1.2024 / producer has the right to make changes of technical data, technical data are valid on 1.1.2024

- pila na fotografii není vždy v základním provedení, uvedené rozměry odpovídají stroji v základním provedení / the machine in the picture is not always in the basic version, mentioned diameters are for machine in basic version

* doporučená hodnota. Při překročení doporučeného maximálního průměru není možné garantovat výkon pilového pásu! / recommended value. The blade performance cannot be guaranteed when the recommended diameter is exceeded!

 - řezání svazků bez horního přitlačení / cutting of the bundle without top clamping



PEGAS - GONDA s.r.o.
Čs.armády 322, 684 01 Slavkov u Brna,
CZECH REPUBLIC

www.pegas-gonda.cz
00420-544 221 125 (126) | pegas@gonda.cz